

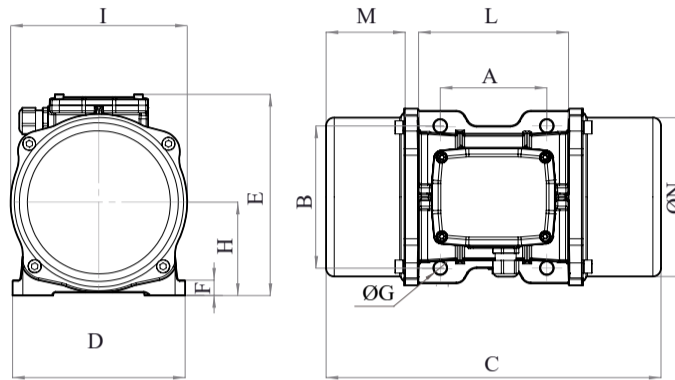

MVE 200/1E-40A0 [EE60020040A0JA0000]

3 PH - 6 poles - 1000 RPM - 220-240/380-415 V - 50 Hz

Working moment [Kg*cm]	Unbalance [Kg*cm]	Centrifugal force [Kg]	Nominal voltage [V]	Input power [kW]	Current [A]	Power factor	Ia/In
33,49	16,75	187	220-240/380-415	0,15	Δ 1,12 Y 0,65	0,33	2,2







*Technical drawings are illustrative purposes only, please refer to 2D/3D drawings available on "FINDER" app. Contact us for more information.

OVERALL DIMENSIONS [mm]													
Weight [Kg]	A	B	G	Holes number	C	D	E	F	H	I	L	M	N
18,8	105	140	13	4	330	170	196	20	92	174	166	78	160

TECHNICAL FEATURES						
Type of grease	Greased for life	Screw	Washer	Clamping torque [Nm]	Cable type	Cable gland
/	Yes	M12	13 x 24 mm	80	4G2.5 120°C	M20 120°C

BEARINGS LIFE HOURS				
Bearing model	Type	100% C.F	80% C.F	50% C.F
6306 2Z		>100000	>100000	>100000

CERTIFICATION	
ATEX II2 D Ex tb IIIC Tx Db IP66 IECEx Ex tb IIIC Tx Db IP66 CLASS II DIV.2 GROUP F,G T4 Ex tb IIIC Tx Db IP66 [Tx Size Micro,10-30:100°C - Tx Size 40-91:135°C] CONFTO UL1004-3, UL1004-1,UL 60079-0,UL60079-31 CERT. CSA C22.2 No.100,CSA C22.2 No.77, CSA C22.2N.60079-0,CSA C22.2N. 60079-31 T.Amb -20/+40°C	    

REV.1-22/05/2019

Dimension with coarse degree of accuracy related to UNI 22768/1 Rights reserved to modify technical specifications.