

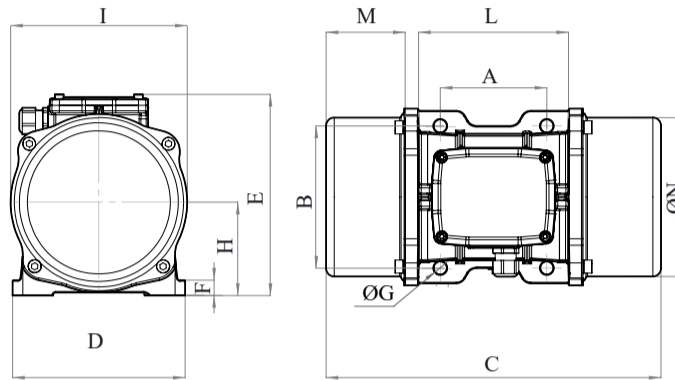

MVE 800/3E-50A0 (EE20080050A0JA0000)

3 PH - 2 poles - 3000 RPM - 220-240/380-415 V - 50 Hz

Working moment [Kg*cm]	Unbalance [Kg*cm]	Centrifugal force [Kg]	Nominal voltage [V]	Input power [kW]	Current [A]	Power factor	Ia/In
15,68	7,84	794	220-240/380-415	0,7	Δ 2,51 Y 1,45	0,7	4







*Technical drawings are illustrative purposes only, please refer to 2D/3D drawings available on "FINDER" app. Contact us for more information.

OVERALL DIMENSIONS [mm]													
Weight [Kg]	A	B	G	Holes number	C	D	E	F	H	I	L	M	N
20,3	120	170	17	4	321	208	210	22	96	185	192	62	170

TECHNICAL FEATURES						
Type of grease	Greased for life	Screw	Washer	Clamping torque [Nm]	Cable type	Cable gland
/	Yes	M16	17 x 30 mm	185	4G2.5 120°C	M20 120°C

BEARINGS LIFE HOURS				
Bearing model	Type	100% C.F	80% C.F	50% C.F
6306 2Z		1110	2168	8881

CERTIFICATION	
ATEX II2 D Ex tb IIIC Tx Db IP66 IECEx Ex tb IIIC Tx Db IP66 CLASS II DIV.2 GROUP F,G T4 Ex tb IIIC Tx Db IP66 [Tx Size Micro,10-30:100°C - Tx Size 40-91:135°C] CONFTO UL1004-3, UL1004-1,UL 60079-0,UL60079-31 CERT. CSA C22.2 No.100,CSA C22.2 No.77, CSA C22.2N.60079-0,CSA C22.2N. 60079-31 T.Amb -20/+40°C	    

REV.1-22/05/2019

Dimension with coarse degree of accuracy related to UNI 22768/1 Rights reserved to modify technical specifications.