

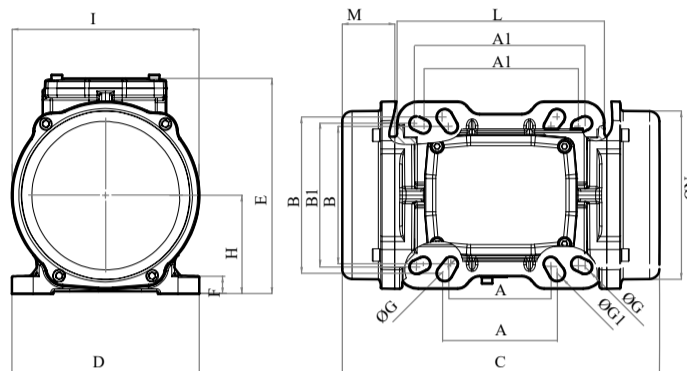

MVE 300/3E-30A0 (EE20030030A0JA0000)

3 PH - 2 poles - 3000 RPM - 220-240/380-415 V - 50 Hz

Working moment [Kg*cm]	Unbalance [Kg*cm]	Centrifugal force [Kg]	Nominal voltage [V]	Input power [kW]	Current [A]	Power factor	Ia/In
6,39	3,2	321	220-240/380-415	0,25	Δ 0,9 Y 0,52	0,69	3,8







*Technical drawings are illustrative purposes only, please refer to 2D/3D drawings available on "FINDER" app.
Contact us for more information.

OVERALL DIMENSIONS [mm]																
Weight [Kg]	A	A1	B	B1	G	G1	Holes number	C	D	E	F	H	I	L	M	N
9,8	80-90	124-135	110-125	110-115	11	13	4	254	150	173	15	79	150	166	42	134

TECHNICAL FEATURES						
Type of grease	Greased for life	Screw	Washer	Clamping torque [Nm]	Cable type	Cable gland
/	Yes	M10-M12	10,5 x 20 - 13 x 24 mm	45-80	4G2.5 80°C	M20 80°C

BEARINGS LIFE HOURS				
Bearing model	Type	100% C.F	80% C.F	50% C.F
6304 2Z		3072	6000	24574

CERTIFICATION	
ATEX II2 D Ex tb IIIC Tx Db IP66 IECEx Ex tb IIIC Tx Db IP66 CLASS II DIV.2 GROUP F,G T4 Ex tb IIIC Tx Db IP66 [Tx Size Micro,10-30:100°C - Tx Size 40-91:135°C] CONFTO UL1004-3, UL1004-1,UL 60079-0,UL60079-31 CERT. CSA C22.2 No.100,CSA C22.2 No.77, CSA C22.2N.60079-0,CSA C22.2N. 60079-31 T.Amb -20/+40°C	    

REV1-22/05/2019

Dimension with coarse degree of accuracy related to UNI 22768/1 Rights reserved to modify technical specifications.